

Aluminium Profiles 工业铝型材系列



Industrial Automation Machine
& accessories

工业铝型材整机&配件

宁波得发科技有限公司
Ningbo Defa Technology Co.,Ltd.

Aluminium Profiles 工业铝型材系列

Profile 20 Series 20系列

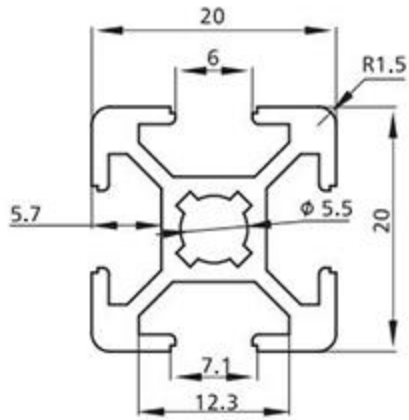

FP-2020

Slot 槽口	Item No. 产品编号	Spec.规格	Material 材质	Finish 表面处理	Weight(kg/m)
	FP-2020	20*20	Alu. 6063-T5	Sand Blasting 喷沙氧化	0.40

Profile 30 Series 30系列

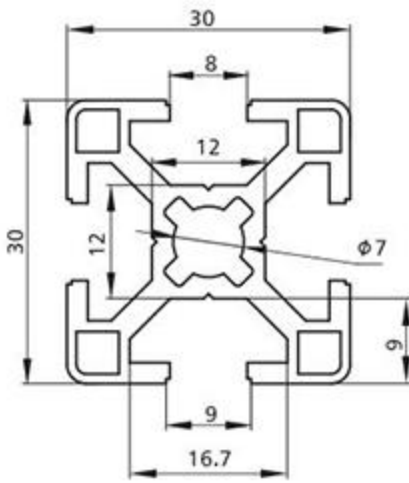

FP-4574

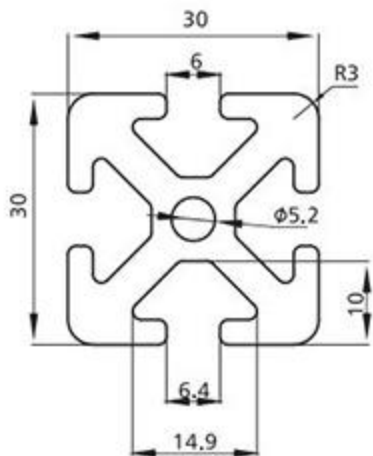

FP-3765

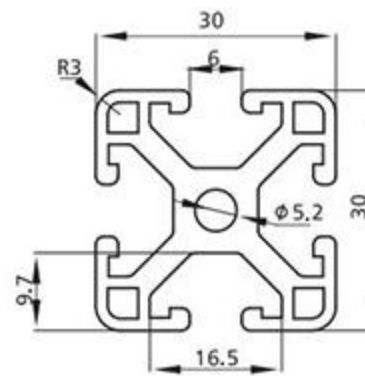

FP-3766

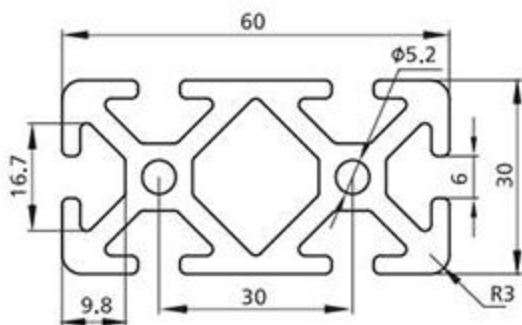

FP-3768

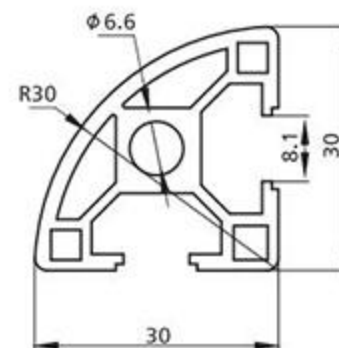

FP-3030R

Slot 槽口	Item No. 产品编号	Spec.规格	Material 材质	Finish 表面处理	Weight(kg/m)
	FP-4574	30*30	Alu. 6063-T5	Sand Blasting 喷沙氧化	0.82
	FP-3765	30*30S	Alu. 6063-T5	Sand Blasting 喷沙氧化	1.25
	FP-3766	30*30L	Alu. 6063-T5	Sand Blasting 喷沙氧化	0.90
	FP-3768	30*60S	Alu. 6063-T5	Sand Blasting 喷沙氧化	2.30
	FP-3030R	30*30R	Alu. 6063-T5	Sand Blasting 喷沙氧化	0.77

Aluminium Profiles 工业铝型材系列

Profile 40 Series 40系列

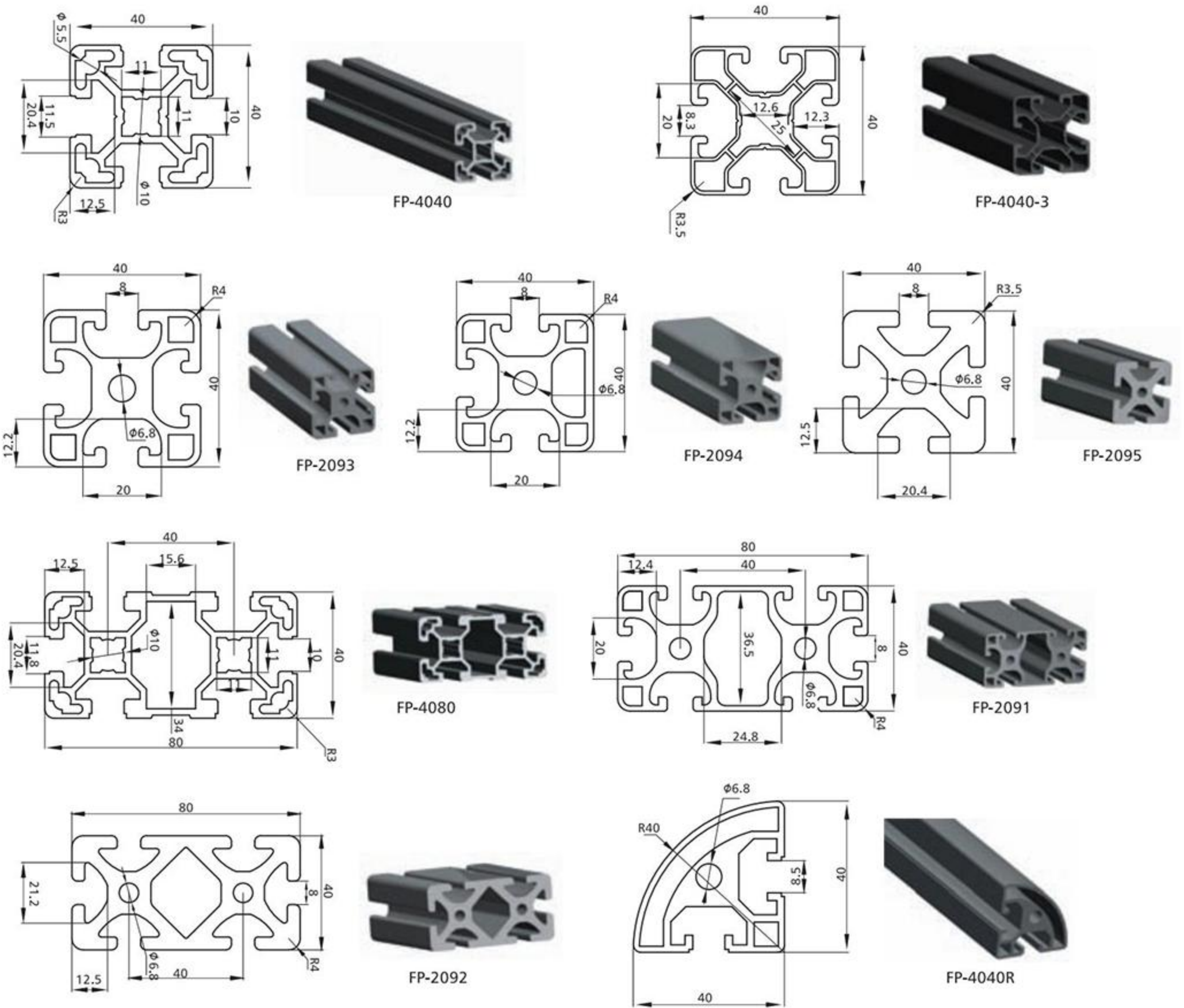

Slot 槽口	Item No. 产品编号	Spec.规格	Material 材质	Finish 表面处理	Weight(kg/m)
	FP-4040	40*40	Alu. 6063-T5	Sand Blasting 喷沙氧化	1.50
	FP-4040-3	40*40	Alu. 6063-T5	Sand Blasting 喷沙氧化	0.87
	FP-2093	40*40L	Alu. 6063-T5	Sand Blasting 喷沙氧化	1.80
	FP-2094	40*40L 1N	Alu. 6063-T5	Sand Blasting 喷沙氧化	1.80
	FP-2095	40*40S	Alu. 6063-T5	Sand Blasting 喷沙氧化	2.40
	FP-4080	40*80	Alu. 6063-T5	Sand Blasting 喷沙氧化	2.70
	FP-2091	40*80L	Alu. 6063-T5	Sand Blasting 喷沙氧化	3.10
	FP-2092	40*80S	Alu. 6063-T5	Sand Blasting 喷沙氧化	4.50
	FP-4040R	40*40R	Alu. 6063-T5	Sand Blasting 喷沙氧化	1.40

Aluminium Profiles 工业铝型材系列

Profile 45 Series 45系列

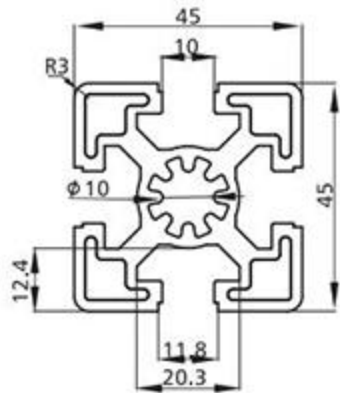

FP-2513

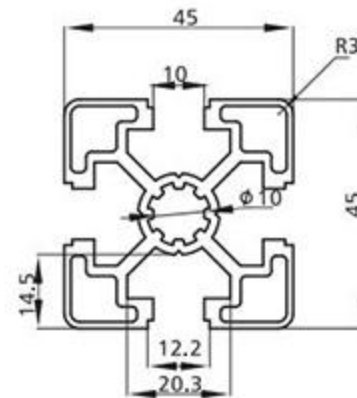

FP-4569

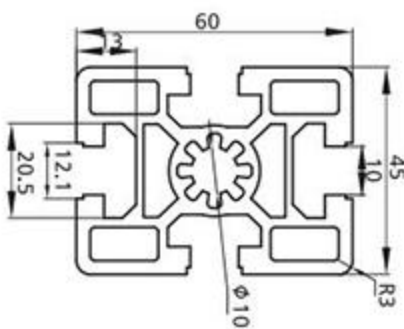

FP-2007

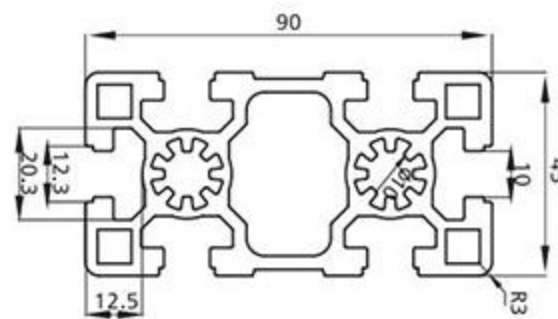

FP-2798

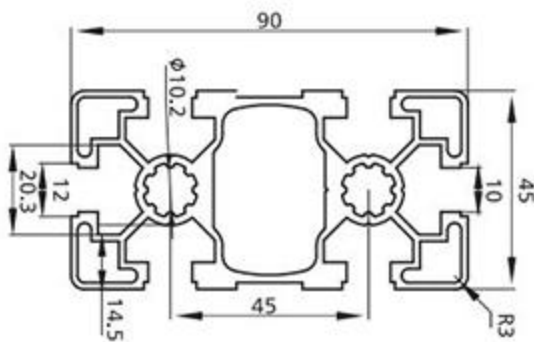

FP-2796

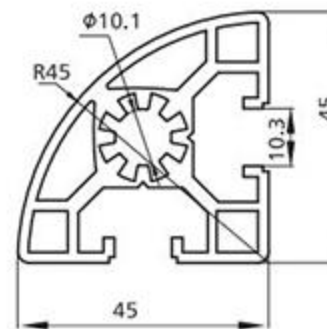

FP-4545R

Slot 槽口	Item No. 产品编号	Spec.规格	Material 材质	Finish 表面处理	Weight(kg/m)
	FP-2513	45*45	Alu. 6063-T5	Sand Blasting 喷沙氧化	1.90
	FP-4569	45*45L	Alu. 6063-T5	Sand Blasting 喷沙氧化	1.60
	FP-2007	45*60	Alu. 6063-T5	Sand Blasting 喷沙氧化	3.00
	FP-2798	45*90	Alu. 6063-T5	Sand Blasting 喷沙氧化	4.10
	FP-2796	45*90L	Alu. 6063-T5	Sand Blasting 喷沙氧化	3.20
	FP-4545R	45*45R	Alu. 6063-T5	Sand Blasting 喷沙氧化	1.64

Profile 80 Series 80系列

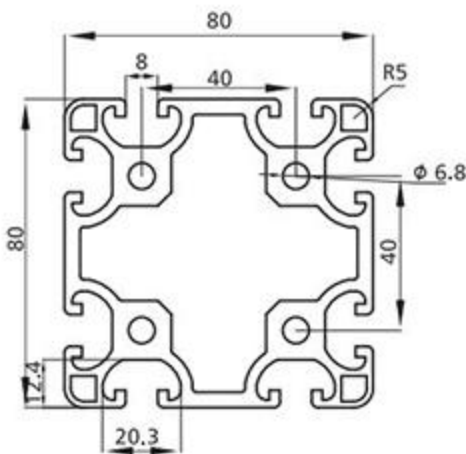

Slot 槽口	Item No. 产品编号	Spec.规格	Material 材质	Finish 表面处理	Weight(kg/m)
	FP-2089	80*80L	Alu. 6063-T5	Sand Blasting 喷沙氧化	5.03

Chinese Standard 国标系列

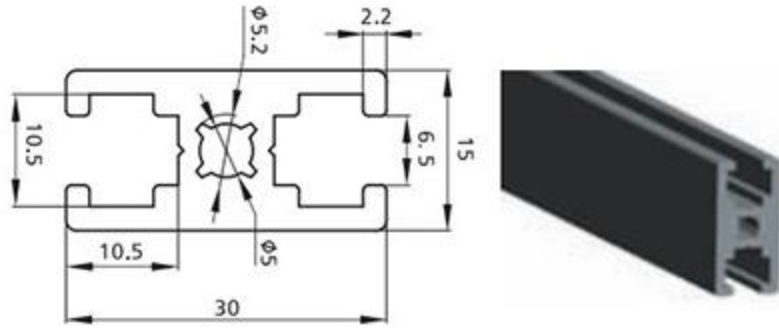

FP-1530

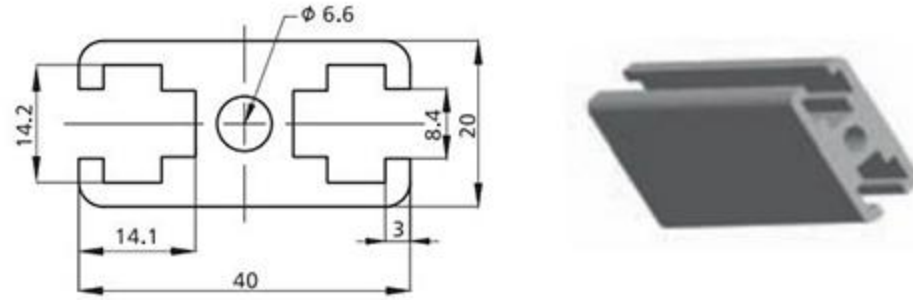

FP-2040

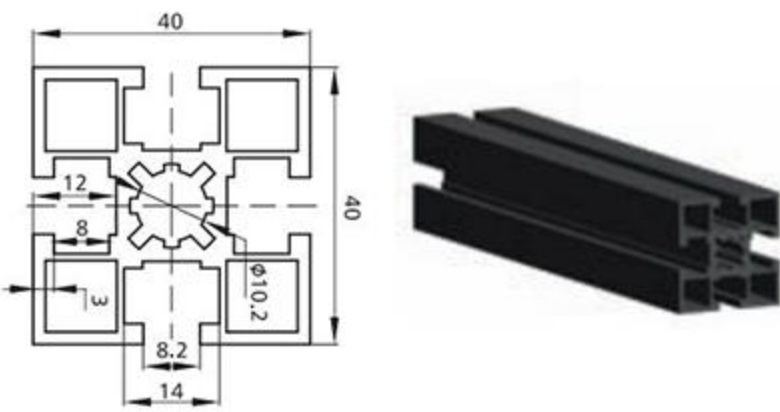

FP-4040-2

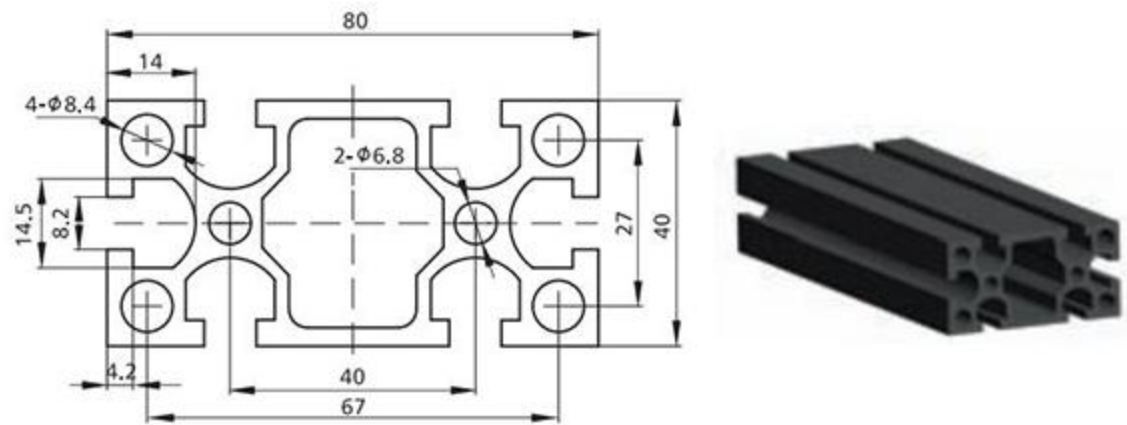

FP-4080-2

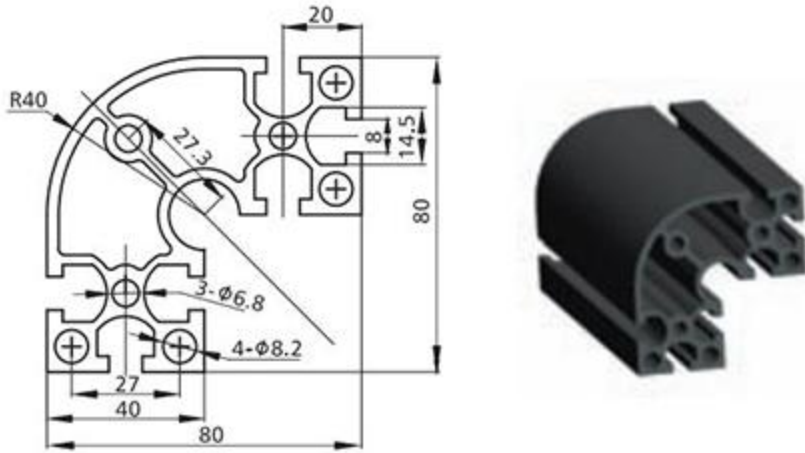

FP-8840R

Slot 槽口	Item No. 产品编号	Spec.规格	Material 材质	Finish 表面处理	Weight(kg/m)
	FP-1530	15*30	Alu. 6063-T5	Sand Blasting 喷沙氧化	0.66
	FP-2040	20*40	Alu. 6063-T5	Sand Blasting 喷沙氧化	1.19
	FP-4040-2	40*40	Alu. 6063-T5	Sand Blasting 喷沙氧化	1.20
	FP-4080-2	40*80	Alu. 6063-T5	Sand Blasting 喷沙氧化	2.90
	FP-8840R	40*80R	Alu. 6063-T5	Sand Blasting 喷沙氧化	4.00